

iCombi[®] Pro.

The WOW effect.



iCombi live



The iCombi Pro. With integrated cooking expertise.

The WOW effect in less than approx. 1 m². For meat, fish, poultry, vegetables and baked goods. For front cooking, à la carte, production. This combi-steamer does it all. Regardless of who is operating it. This is because it contains the experience of more than 1,000 chefs. The experience of manufacturing over a million cooking systems. This makes the iCombi Pro the intelligent combi-steamer with integrated cooking expertise. Which translates to astonishing user benefits. In short: the WOW effect.

An intelligent combination of heat and moisture.

A convection oven and a steamer in a single appliance. Enhanced with integrated cooking intelligence. For a wealth of new possibilities in professional food preparation. The iCombi Pro yields reliably excellent results every single time. While saving time, money and energy in the process. Not to mention replacing a variety of conventional kitchen appliances by covering 95% of all common cooking applications.



Steam



Steam & heat



Heat



More
information

Benefits to you.

Excellent results.

For your customers.

The iCombi Pro specialises in putting great results onto plates Over and over again. Dishes with appetising colour and texture, cooked to uniform perfection from the first rack to the last, with vitamins and minerals preserved.

Easy to use.

For everyone.

Anybody can work with the iCombi Pro. One reason is the large, easy to operate touch display: find the ideal cooking path intuitively, customise display settings, network cooking systems. The result? Minimal orientation time on an appliance that's easy and safe to use.

Clean.

Like new.

Hygiene is an essential part of kitchen work, and another area where iCombi Pro is a reliable partner. Records HACCP data during cooking. Ensures total cleanliness with an automatic cleaning system.



Excellent results.



User friendly.



High hygiene standards.



Efficient work processes.



Time savings.



Investment peace of mind.

Benefits to you.

Efficient work processes.

For your team.

The iCombi Pro can work overnight, prepare multiple dishes at once, make sure everything is ready at a specified time, and even find the most energy-saving production sequence. That's the process reliability users need to keep costs and quality under control

Saves time.

Your time.

The iCombi Pro can save users a lot of time. Having extra time takes the pressure off the kitchen staff so they can work efficiently and deliver even tastier results. That's why we made the iCombi Pro powerful and easy to operate, with an ultra-fast interim cleaning function.

Your investment.

To keep your mind at ease.

Compared to conventional kitchen technology, the iCombi Pro significantly reduces energy, operation, maintenance, water softening and descaling expenses. Together with a long appliance service life, that adds up to a secure investment.



Monitoring and assistance. Integrated cooking expertise.

Only the iCombi Pro can calculate the perfect route to the desired cooking results.

- > Select desired result (e. g. browning or core temperature)
- > Detects the load and automatically adjusts the cooking process to the food
- > Responds to outside influences, such as opening of the cooking cabinet door
- > Adapts to the operator's cooking habits
- > Only alerts users when they need to do something
- > Users can intervene at any time, e.g., to switch from single products to mixed loads

Benefits:



iCookingSuite 

RATIONAL
iCombi Pro



Monitoring and assistance.

Your intelligent assistant in everyday kitchen work.

An operating concept that sets standards: quality results, quickly and easily. With the large, clear touch display with intuitive icons. With a rotary dial with push function. For optimal support in daily use.



Intelligent regulation and interactive communication thanks to the iCombi Pro cooking intelligence. Which adjusts cooking processes individually to each dish, adapts to operator's habits and only alerts them when something needs doing.

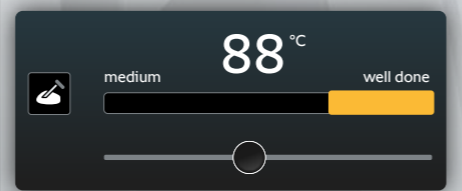

The integrated core probe's six measurement points detect product sizes and quantities, so every dish reaches the set core temperature – and the target results – precisely. The dish is prepared exactly the same way next time.

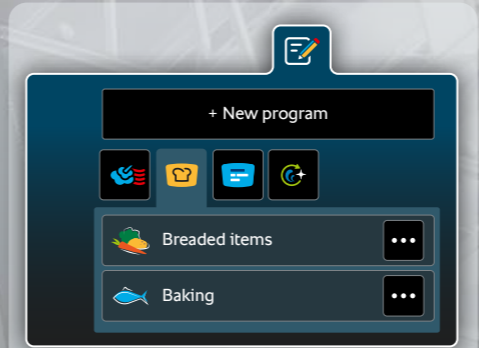

Preset cooking processes, custom or manual. The programming function offers a variety of options for customising work processes.



Low temperature cooking, hold or Smoking*. Pasteurisation*. Finishing. These cooking processes and options can be selected as required. This makes handling simple and ensures food quality.

* Accessory required



Create and distribute cooking programs, update cooking system software, document HACCP data and access the cooking system remotely with ConnectedCooking, the digital kitchen management solution.



Precise climate.

Performance affects taste.

Uniform results throughout the cooking cabinet, from the first rack to the last.

- › Combination of heat and moisture is automatically adjusted
- › Powerful steam generator delivers exceptional results on even the most delicate dishes
- › Powerful fan wheels
- › 300°C maximum cooking cabinet temperature
- › Enormous de-humidification power
- › Optimum cooking cabinet geometry

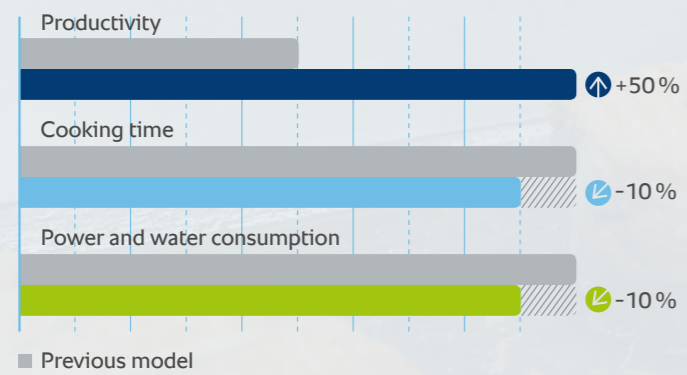

Benefits:



iDensityControl 

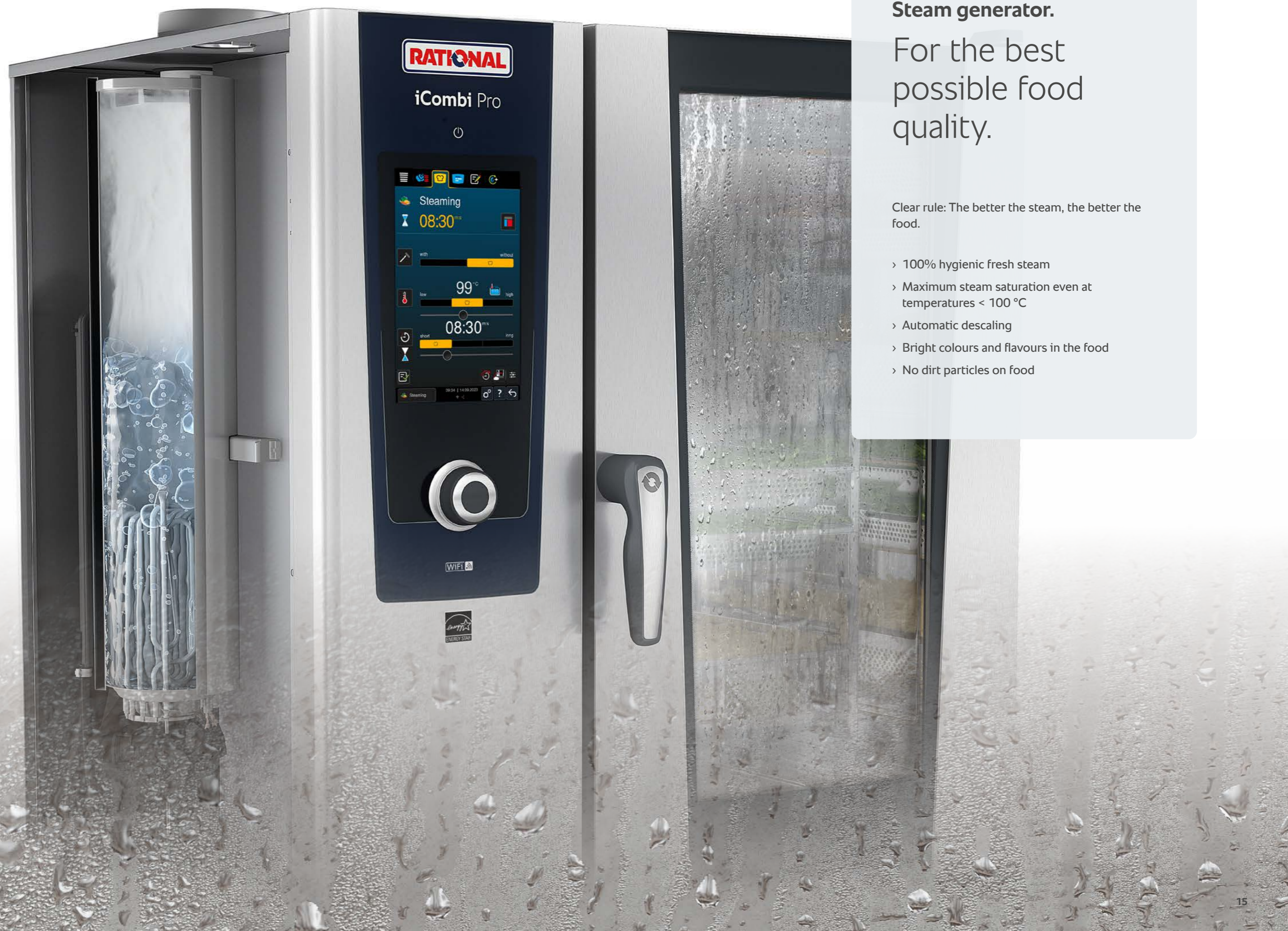

Steam generator.

For the best possible food quality.

Clear rule: The better the steam, the better the food.

- > 100% hygienic fresh steam
- > Maximum steam saturation even at temperatures < 100 °C
- > Automatic descaling
- > Bright colours and flavours in the food
- > No dirt particles on food



Flexible planning.

Ready at the same time and at the right time.

Save yourself the logistical effort – leave everything to the iCombi Pro.

- > Prepare different products simultaneously
- > Adjusts cooking times based on load sizes and door opening times
- > Notifies users when food needs to be loaded or unloaded
- > Planning function: optimised for speed, energy consumption, efficient production sequence or a specified production time
- > Even simpler: creation of shopping baskets and planning with ConnectedCooking

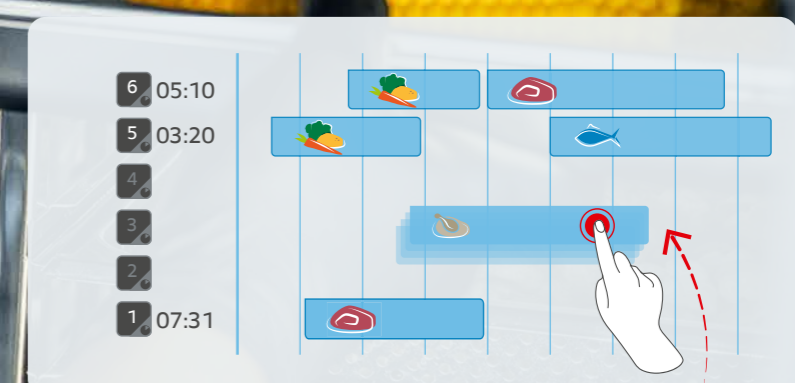

Benefits:



iProductionManager 



Cleaning and descaling.

An answer to any type of grime.

- > Automatic cleaning and descaling
- > Detects whether it is lightly, moderately or heavily soiled
- > Suggests an ideal cleaning program from 9 options
- > Ultra-fast cleaning in approx. 12 minutes
- > Optional for selected tabletop units: iCareSystem AutoDose, the only autonomous cleaning system with a safely integrated supply of solid chemicals.



More on
iCareSystem AutoDose



Benefits:



iCareSystem⁺



Individualisation.

Because everyone works differently.

Each kitchen has its own concept, yet the iCombi Pro can still cover them all.

- > Programing: Create custom cooking programs
- > MyDisplay: Show dishes, shopping carts and permissions on the display as images or icons
- > Configure settings directly on the cooking system
- > ConnectedCooking: digital asset, recipe and hygiene management
- > More than 50 system languages



Benefits:



Economy.

Energy down, quality up.

The iCombi Pro not only cooks intelligently, it also saves intelligently.

- › Requires 18% less energy*
- › Digital energy consumption display lets users document, monitor and reduce their energy use
- › ConnectedCooking dashboard displays areas of potential savings
- › Meets newest Energy Star standards (Jan. 2023)



Benefits:



* Compared to pre-2016 combi-steamers.

Let's do the maths together.

What makes a kitchen successful? It has to be worth the investment. Here's how the iCombi Pro does it:

- › Ready for immediate use
- › Replaces numerous kitchen appliances
- › Renders additional investments unnecessary
- › Saves space, working time, ingredients, energy and water
- › Extremely short ROI time

Your profit	Calculation approach per month	Your additional earnings per month	ROI time under 1 year	Do the calculation for yourself
Meat / Fish / Poultry				
An average of 25 %* less raw materials purchased thanks to precise regulation and iCookingSuite.	Cost of goods S\$ 7,000	= S\$ 1,750		
	Cost of goods with iCombi Pro S\$ 5,250			
Energy				
The unique cooking performance, iProductionManager and state of the art control technology consume up to 70 %* less energy.	Consumption 6,300 kWh × S\$ 0.30 per kWh	= S\$ 1,323		
	Consumption with iCombi Pro 1,890 kWh × S\$ 0.30 per kWh			
Fat				
There is almost no need for fat. Procurement and disposal costs for fat are reduced by up to 95 %*.	Cost of goods S\$ 66	= S\$ 63		
	Cost of goods with iCombi Pro S\$ 3			
Working time				
iProductionManager reduces production time by up to 60 %*. No more routine tasks with iCookingSuite.	60 fewer hours × S\$ 12	= S\$ 720		
Water softening / descaling				
These costs are eliminated entirely with iCareSystem.	Conventional costs S\$ 88	= S\$ 88		
	Costs with iCombi Pro S\$ 0			
Your extra earnings per month		= S\$ 3,944		
Your extra earnings per year		= S\$ 47,328		

The average hotel restaurant with 200 meals per day with two iCombi Pro 10-1/1.

* Compared to conventional kitchen technology without combi-steamers

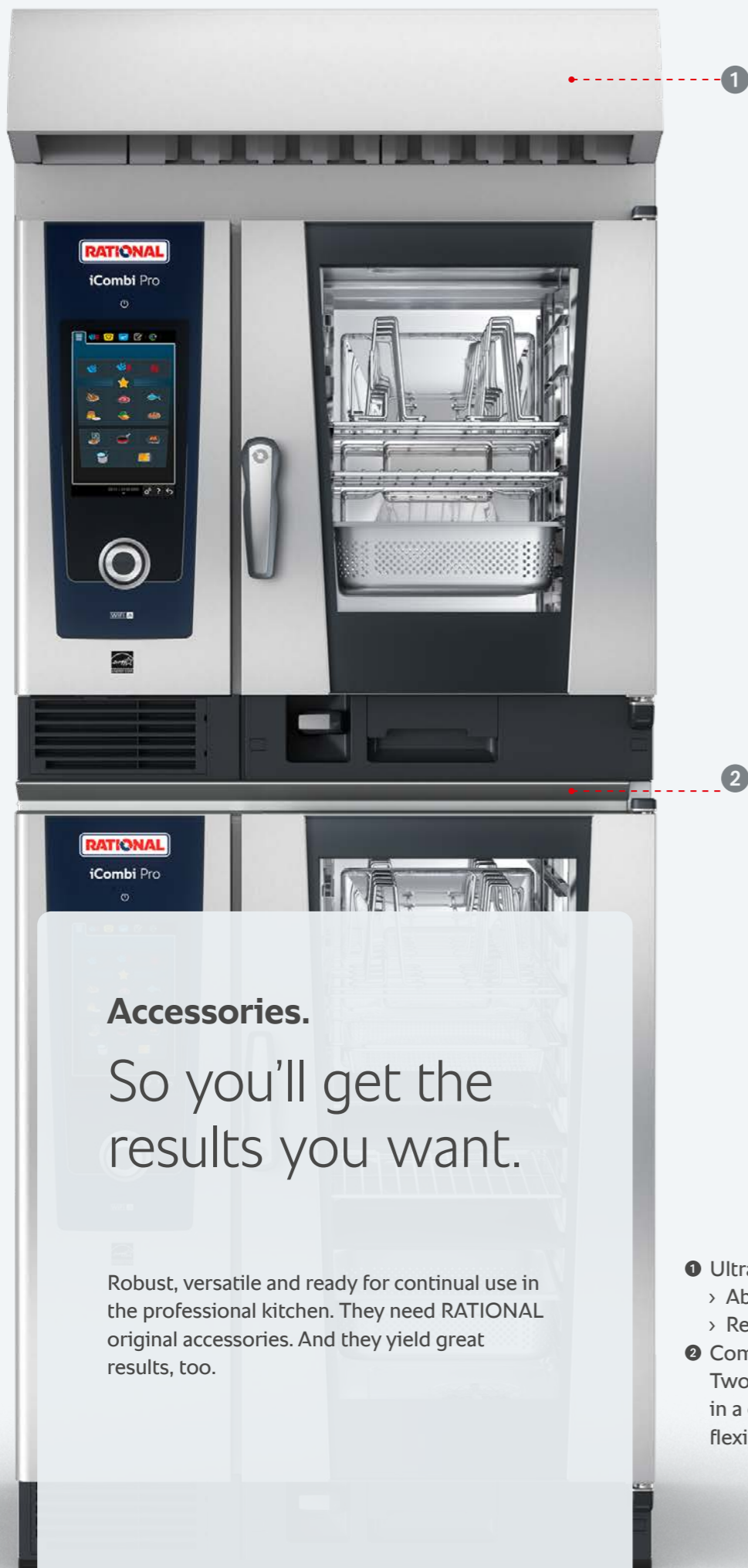

Accessories.

So you'll get the results you want.

Robust, versatile and ready for continual use in the professional kitchen. They need RATIONAL original accessories. And they yield great results, too.

- ❶ UltraVent Plus
 - › Absorbs steam and grease
 - › Reduces unpleasant vapours
- ❷ Combi-Duo kit
 - Two cooking systems combined in a convenient stack. For more flexibility.

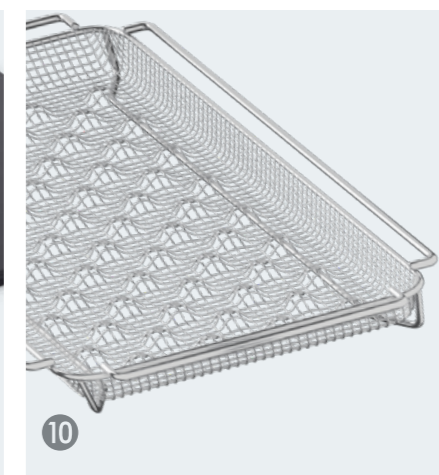
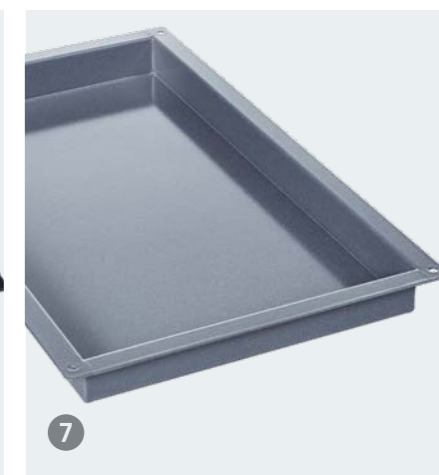

- ❸ Cross and stripe grill grate
- ❹ VarioSmoker
- ❺ Multibaker
- ❻ Roasting and baking tray
- ❼ Granite-enamelled container
- ❽ Sous-vide and pasteuriation kit
- ❾ Grill and pizza tray
- ❿ CombiFry frying basket



More information



Quality and sustainability.

Out of respect
for humanity and
nature.

RATIONAL solutions and policies create added value in pursuit of global well-being and a resource-conserving, climate-neutral future. This means:

- › Longer product life cycles thanks to high quality standards and precise workmanship
- › Development of cooking systems that require less water and energy
- › High quality appliances that require less upkeep, service and maintenance
- › High proportion of recyclable materials
- › Digitised, ergonomic solutions for greater user well-being

Technical details.

We've thought of everything.



- 1 LED lighting with rack signalling
- 2 6-point core probe
- 3 Integrated hand shower with jet and spray function
- 4 Dynamic air circulation
- 5 3-pane cooking cabinet door
- 6 Steam generator

IP X5

WiFi

RATIONAL Services.

Here's to a beautiful partnership.

RATIONAL after-sales services. Ensuring your investment pays off in the long term, that you always get the most out of your cooking systems and that you never run out of ideas.

- > Installation by certified Service Partners
- > Unit Introduction
- > Free software updates
- > ChefLine, the free RATIONAL hotline
- > RATIONAL Academy

Overview of models.

Which model is the right one for you?



The iCombi Pro is available in many different sizes, so you'll always find one to fit your needs. 20 meals or 2,000? Front of house cooking? Kitchen size? Electricity? Gas? Which model is suitable for your kitchen?

All the options, equipment features and accessories at: rational-online.com

iCombi Pro	XS 6-2/3	6-1/1	10-1/1	6-2/1	10-2/1	20-1/1	20-2/1
Electric and gas							
Capacity	6 × 2/3 GN	6 × 1/1 GN	10 × 1/1 GN	6 × 2/1 GN	10 × 2/1 GN	20 × 1/1 GN	20 × 2/1 GN
Number of meals per day	20–80	30–100	80–150	60–160	150–300	150–300	300–500
Lengthwise loading (GN)	1/2, 2/3, 1/3, 2/8 GN	1/1, 1/2, 2/3, 1/3, 2/8 GN	1/1, 1/2, 2/3, 1/3, 2/8 GN	2/1, 1/1 GN	2/1, 1/1 GN	1/1, 1/2, 2/3, 1/3, 2/8 GN	2/1, 1/1 GN
Width	655 mm	850 mm	850 mm	1072 mm	1072 mm	877 mm	1082 mm
Depth (including door handle)	555 (621) mm	775 (842) mm	775 (842) mm	975 (1042) mm	975 (1042) mm	847 (913) mm	1052 (1117) mm
Height (including ventilation pipe)	567 (594) mm	754 (804) mm	1014 (1064) mm	754 (804) mm	1014 (1064) mm	1807 (1872) mm	1807 (1872) mm
Water inlet	R 3/4"	R 3/4"	R 3/4"	R 3/4"	R 3/4"	R 3/4"	R 3/4"
Drain	DN 40	DN 50	DN 50	DN 50	DN 50	DN 50	DN 50
Water pressure	1.0 - 6.0 bar	1.0 - 6.0 bar	1.0 - 6.0 bar	1.0 - 6.0 bar	1.0 - 6.0 bar	1.0 - 6.0 bar	1.0 - 6.0 bar
Electric							
Weight	62 kg	100 kg	133 kg	135 kg	173 kg	254 kg	325 kg
Connected load	5.7 kW	10.8 kW	18.9 kW	22.4 kW	37.4 kW	37.2 kW	67.9 kW
Fuse	3 × 10 A	3 × 16 A	3 × 32 A	3 × 35 A	3 × 63 A	3 × 63 A	3 × 100 A
Mains connection	3 NAC 400 V	3 NAC 400 V	3 NAC 400 V	3 NAC 400 V	3 NAC 400 V	3 NAC 400 V	3 NAC 400 V
Convection mode output	5.4 kW	10.25 kW	18 kW	21.6 kW	36 kW	36 kW	66 kW
Steam mode output	5.4 kW	9 kW	18 kW	18 kW	36 kW	36 kW	54 kW
Gas							
Weight		114 kg	149 kg	151 kg	192 kg	273 kg	358 kg
Electrical rating		0.6 kW	0.9 kW	0.9 kW	1.5 kW	1.3 kW	2.2 kW
Fuse		1 × 16 A	1 × 16 A	1 × 16 A	1 × 16 A	1 × 16 A	1 × 16 A
Mains connection		1 NAC 230 V	1 NAC 230 V	1 NAC 230 V	1 NAC 230 V	1 NAC 230 V	1 NAC 230 V
Gas connection		3/4" IG	3/4" IG	3/4" IG	3/4" IG	3/4" IG	3/4" IG
Natural gas/ Liquid gas LPG G30*							
Max. Nominal thermal load		13 kW/13.5 kW	22 kW/23 kW	28 kW/29.5 kW	40 kW/42 kW	42 kW/44 kW	80 kW/84 kW
Convection mode output		13 kW/13.5 kW	22 kW/23 kW	28 kW/29.5 kW	40 kW/42 kW	42 kW/44 kW	80 kW/84 kW
Steam mode output		12 kW/12.5 kW	20 kW/21 kW	21 kW/22 kW	40 kW/42 kW	38 kW/40 kW	51 kW/53.5 kW

* To guarantee proper operation, the appropriate connection flow pressure must be ensured:

Natural gas H G20 18–25 mbar (0.261–0.363 psi). Natural gas L G25: 20–30 mbar (0.290–0.435 psi). LPG G30 und G31: 25–57.5 mbar (0.363–0.834 psi). iCombi Pro (LM100) and iCombi Classic (LM200) models are NSF certified as can be seen on the NSF listing



iCombi live.

Cook with our experts.

Nothing's more convincing than first-hand knowledge. Experience the RATIONAL cooking systems in use, see the functions for yourself and try out to see how you can work with them. Experience the WOW effect. Live, with no obligation and at a location near you.



Register now
+65 68095850
info@rational-online.sg

iCombi live

RATIONAL Cooking Systems Pte Ltd
(a subsidiary of RATIONAL International AG)
25 International Business Park
#02-15/17 German Centre
Singapore, 609916

Tel +65 68095850
Fax +65 68095899

info@rational-online.sg
rational-online.com

